

**TowerTray™** for HP LaserJet 4200, 4300, 4250, 4350

# Installation and User's Guide





**Manual TowerTray™ for  
Hewlett-Packard LaserJet 4250 / 4350 Printers**

TABLE OF CONTENTS	1
PREFACE	3
UNPACKING	4
BOX CONTENTS	6
INSTALLATION	
Hardware Installation	7
Printer Panel Settings	11
Software Installation	12
How to turn the system on	13
Upgrade for HP LJ 4250 / 4350	13
OPERATING	
Reloading Paper	14
Out of Paper	14
Paper Jam	14
PAPER QUALITY GUIDELINES	16
APPENDIX A - Printer Specific Notes	17
APPENDIX B - Tips & Hints	18
APPENDIX C - Standard Applications	22
APPENDIX D - PCL Paper Selection Commands	23
APPENDIX E - Troubleshooting	24
APPENDIX F - Printer Selftest Pages	26
Configuration Page	27
Paper Handling Configuration Page	28
Event Log Page	29
APPENDIX G - TowerTray Selftest	30
APPENDIX H - Cleaning and Maintenance	31
APPENDIX I - TowerTray Specifications	32



Congratulations! You selected TowerTray, a modular expandable, sheet feeder specifically designed in collaboration with Hewlett-Packard, USA, to extend the paper handling capabilities of the HP LaserJet 4200 / 4300 / 4250 / 4350.

The TowerTray Option offers new possibilities. You can

- **select from up to 9 different paper types directly from your PC.**
- **print extra copies instead of going to the copier to make copies.** You get better copies and you can color code copies of documents on color paper to help clearly identify a copy. The color already defines the addressee and you will save the marking of the copies.
- **realize an attractive alternative to the multi-part forms printed on conventional impact printers.** You will get better copies, raise the flexibility and you will save money on expensive preprints and chemical papers.

We encourage you to read this manual carefully to ensure correct installation and reliable operation. While installing TowerTray, or whenever an unclear situation arises, please also consult the user's manuals of your HP LaserJet 4200 / 4300 / 4250 / 4350, your computer system, your application software and your network software.

The name TowerTray is generic to the TowerTray family of automatic sheet feeders and is used throughout this manual.

TowerTray and additional trays for TowerTray (Middle Trays) have these part number assignments:

**TowerTray 221000** ⇒ Part No.: 221000

**Additional Trays** ⇒ Part No.: 206011  
(\*only for TowerTray use)

\* Additional TowerTray trays do work only within the TowerTray setup. For use within the HP LaserJet setup do order the original HP trays via your preferred Hewlett-Packard source. See page 8: Array of Trays and page 17: Original HP 500-Sheet Tray.

A plate showing type, designation and serial number is located next to the power inlet of the TowerTray. Please refer to this designation and the serial number whenever you call your service organization.

D&P International B.V., reserves the right to make changes to its products or services without prior notice and without incurring any obligations to incorporate such changes in units or publications shipped.  
**D&P International B.V. shall in no event be liable for incidental or consequential damages arising from the use of its equipment.**

TowerTray™ is a registered trademark of Rutishauser Data AG.

Windows™ is a registered trademark of Microsoft Corp.

TowerTray Support Software for Windows™ is a copyrighted product of D&P International B.V.

Other products and brand names mentioned are trademarks or registered trademarks of their respective companies.

# UNPACKING

---

**Note:**

Prior to delivery, your TowerTray was thoroughly tested and carefully packaged. Please check your unit for transportation damage and/or missing parts immediately upon receipt.

It is advisable to get a second person to help you unpack the unit.

**Warning:**

TowerTray Base-Unit weighs 25 kilograms (56 pounds). To prevent back strain or injury, bend your knees when lifting the unit, and get help if you need.

To unpack the TowerTray unit, proceed as follows (see figure next page):

- Cut the packing strips and open the top of the shipping container.
- Lift the Top-Module Unit (no. 1) out of the box.
- Remove the accessories box (no.2). It contains the rollers, tilt protection, the power and data cable, one CD-ROM and flyer.
- Lift Base-Unit (no. 3) out of the box. Use two persons for this step due to the weight of the Base-Unit.
- Insert the rollers from the accessories box with some force onto the shafts on the TowerTray Base-Unit until they snap into position with an audible click.
- Bring the TowerTray Base Unit into an upright position.
- Unpack Top-Module and place it on top of TowerTray Base-Unit

**Re-packing**

It is recommended that you keep the packaging material and inserts for proper protection of the unit and its parts in case of reshipment.

To repack TowerTray, follow the above steps in reverse order. Be sure that all accessories including manuals and CD-ROM are packed in the box. Insert the four blue shock absorbers and close the container. Ensure TowerTray is correctly seated and cushioned.

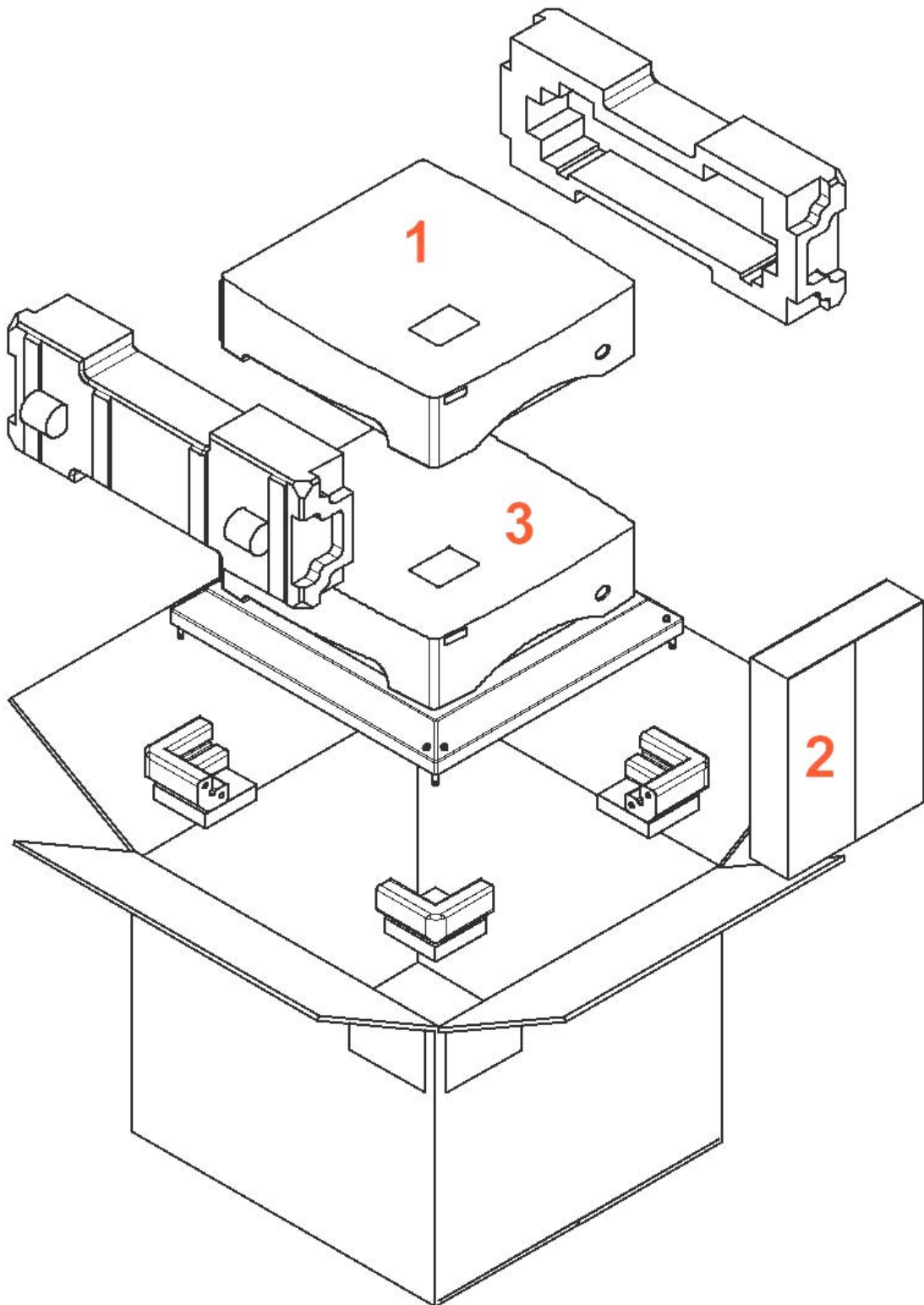

# BOX CONTENTS

**Note:**

Prior to delivery, your TowerTray was thoroughly tested and carefully packaged. Please check your unit for transportation damage and/or missing parts immediately upon receipt.

## Box Contents

- TowerTray Base-Unit
- TowerTray Top-Unit
- Accessories box



## Accessories Box Contents

- TowerTray note
- TowerTray manual and software (CD)
- data cable
- power cable
- two tilt protections
- four rollers
- data cable adapter
- hexagonal wrench
- four hexagonal screws
- one set of self-adhesive labels
- bracket with screws and anchors



**Warning:**

TowerTray may weigh up to 25 kilograms (55 pounds) depending on configuration. To prevent back strain or injury, enlist the help of someone and bend your knees when lifting the unit.

**Warning:**

POWER OFF your printer and TowerTray and disconnect all power and interface cables before you proceed with the installation.

## Hardware Installation

### Remove Transportation Insert

- Pull all the trays out, detach the red tape and remove the transportation inserts.
- Re-insert and close the trays.

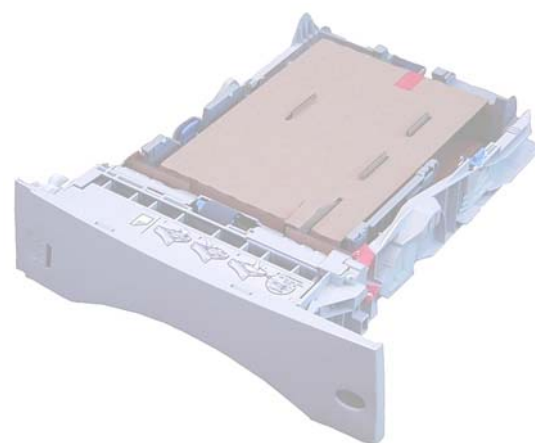

# INSTALLATION

## Position and Connect Printer

**Warning:**

The printer may weigh up to 34 kilograms (75 pounds). Enlist the help of a second person to lift the unit. To prevent back strain or injury, bend your knees when lifting the unit.

**Note:**

To meet requirements for absolute toppling security TowerTray has to be equipped with the supplied tilt protection (see picture). Also, never open more than one tray at the same time.

**Note for HP LaserJet 4250 and 4350 users:**

If you are using more than 2 additional HP Trays, then the TowerTray / HP LaserJet unit has to be fixed to a building wall. To do so, please refer to page 10 of this manual.

- Carefully lift the laser printer onto TowerTray. Make sure you utilize the locking mechanism on the tray's and printer's left side.

**Arrangement of trays:**

The TowerTray Unit can only operate with TowerTray trays whereas the HP LaserJet Unit can only operate with original HP trays. Therefore it is essential not to mix TowerTray trays with the original HP trays – TowerTray trays are easily distinguished by the TowerTray Sticker on it's front panel.

Note: The TowerTray Unit can consist of up to four trays (one Bottom, two middle and one Top tray) .

## Data Connection

**Without Stacker**

Connect printer and TowerTray with the data cable (see picture): one end with the printer and the other end with TowerTray. Use the provided Adapter as a intermediate piece (see picture next page).

**Caution:**

Only move TowerTray to another place with **drawers closed** and **without printer on top** to avoid hazard of toppling. Do not roll the TowerTray with more than 4 trays on top – remove any surplus trays. Drawers need to be secured against unintentional opening. Be careful when crossing doorsteps or different flooring materials. Be sure that the trays interlocking mechanism are applied

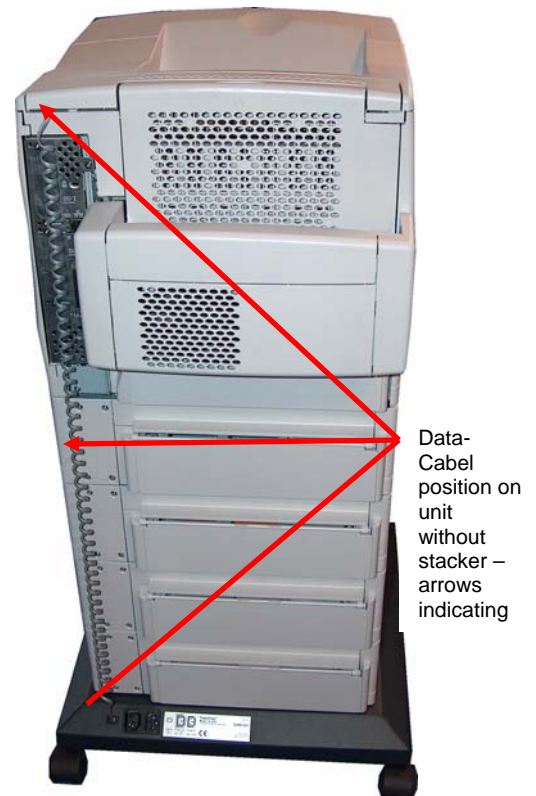

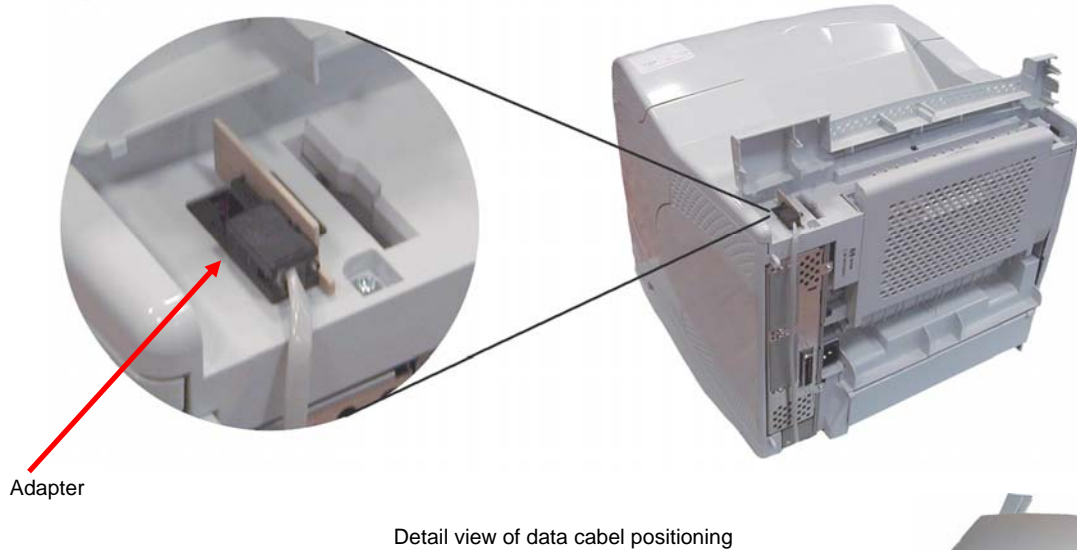

### With stacker

- Connect stacker and TowerTray with the provided data cable (see picture): one end with the stacker and the other end with the TowerTray port. The data communication between TowerTray and printer takes place via stacker.

### Note:

The adapter will not be needed in the configuration with stacker.

### Caution:

Only move TowerTray to another place with **drawers closed** and **without printer on top** to avoid hazard of toppling. Do not roll the TowerTray with more than 4 trays on top – remove any surplus trays. Drawers need to be secured against unintentional opening. Be careful when crossing doorsteps or different flooring materials. Be sure that the tray interlocking mechanism is applied.



Data-Cable position on unit with stacker – arrows indicating connection socket

# INSTALLATION

Cabel position in HP-Stacker after reinstallation

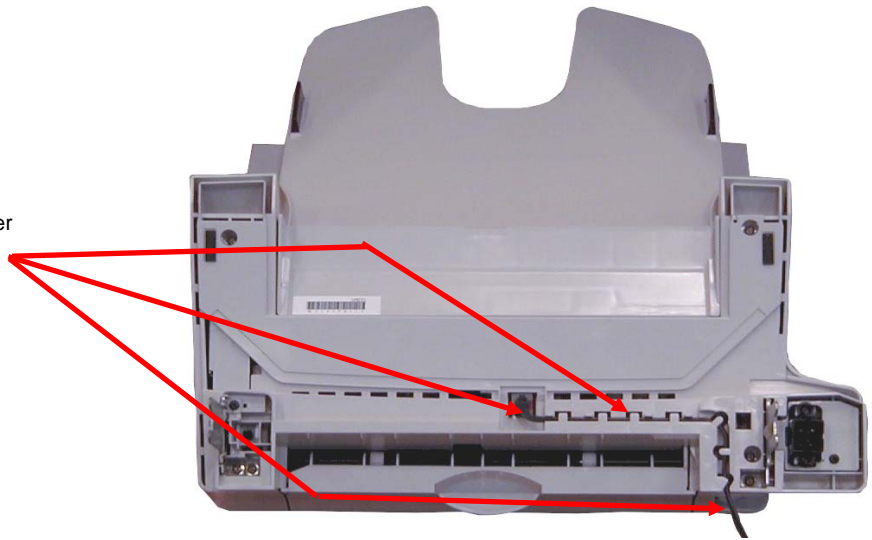

## Numbering of Trays

Depending of how many trays (original HP trays or TowerTray trays) are being used - the TowerTray trays have to be numbered consecutively. To do so put your unit together and attach the supplied number stickers to the designated location (see picture). Start with the first (top most) tray after the HP-Unit and continue with the next number after that one – increase with every tray downwards.



Attach self adhesive number stickers to the appropriate position

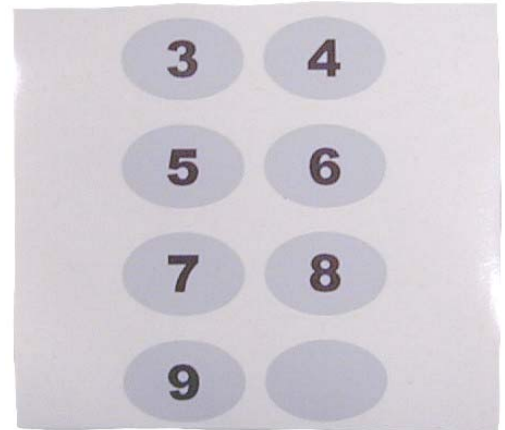

## Fixing the TowerTray to the building (only HP LJ 4250/4350 if using more than 2 HP-Trays)

To meet requirements for absolute toppling security the TowerTray / HP LaserJet 4250/4350 unit has to be fixed to a building wall, if more than 2 additional HP-Trays are used.

Position a: use the HP-Tray screws to affix the provided bracket in the accessory to the topmost HP-Tray.

Position b: use two screws and screw anchors to affix the bracket to the building's wall.

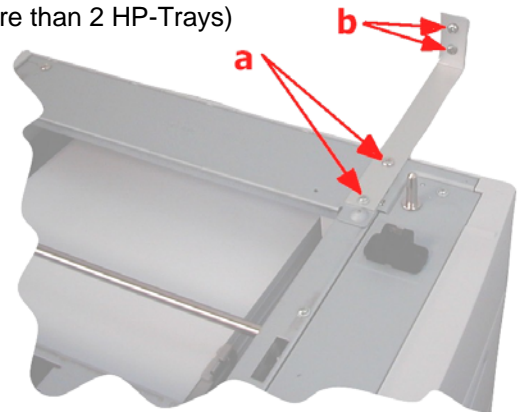

## Printer Panel Settings

### Papertype Assignments

By default, each paper tray has assigned the paper type PLAIN. In case of a paper out in a selected tray, the printer automatically will pull paper from another tray.

The assigning of a different paper type to each tray inhibits the automatic switching of the printer to another tray if the selected tray runs out of paper.

To assign a paper type to an input tray, select with the menu key the PAPER HANDLING MENU and there the specific input tray. Then assign to each tray another one of the 12 predefined paper types.

If you have several trays with the same paper, assign to each of these trays the same paper type. This will increase your input capacity for this paper type, as the printer will automatically switch to the next tray with the same paper type in case the selected tray runs out of paper.

**Note:**

PLAIN is the default paper type. In case a print job arrives without paper selection, the printer will pull paper from the lowest tray containing PLAIN paper (e.g. printer test pages).

## Software Installation

### Installation of Printer Driver

The CD delivered with your TowerTray system contains the HP LaserJet PCL 5e and PCL 6 software supporting the TowerTray option for Windows XP and 2000.

For availability of the most recent printer drivers, please consult our WEB page at: [www.key2printing.com](http://www.key2printing.com)

# INSTALLATION

## Configuring the TowerTray Option

Go to the Control Panel and select *Printers*. There click on the respective HP LaserJet Printer.



Use the right mouse button to open the *Settings*. Then click on the hardware settings icon. There choose the appropriate TowerTray you are using in the pull-down Window, do the same as well with all the other printer equipment you are using (extension tray, duplex, etc.)

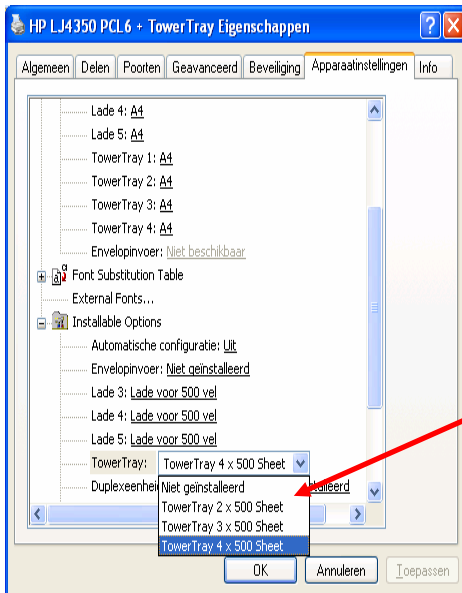

Choose the correct TowerTray model.

**Note:** You must have the correct driver installed to do so.

After having done so the TowerTray trays need to be set on the correct paper size format.

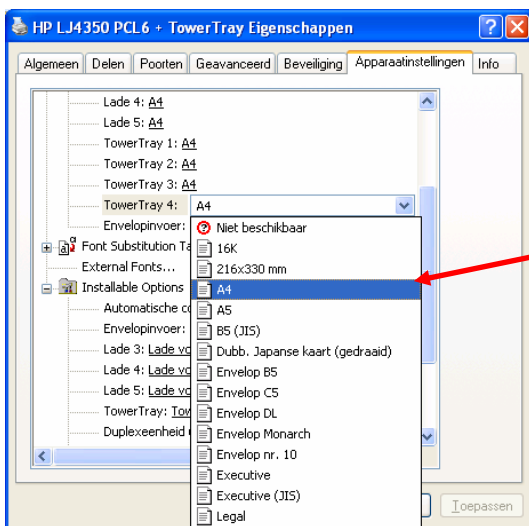

Choose the appropriate paper size format (The paper format you are going to use in your TowerTray)

Now your TowerTray is ready for operation.

**Note:**

For further information on Tray and MediaType definition please refer to Appendix B – Tips and Hints of this manual.

## How to turn the system on

**Note:**

Power ON Printer and the TowerTray will automatically power on by itself if the Printer is plugged in at the TowerTray's power outlet.

Printer plugged in at the TowerTray's power outlet

Original Printer power cord

**Note:**

The TowerTray's power inlet and power outlet are supplied with line voltage, if TowerTray is plugged in.



Power cord supplied with shipment

## Upgrade for HP LaserJet 4250 / 4350

**Note:**

Make sure that your HP LaserJet 4250 or 4350 has been manufactured after Mai 2005 (a serial no. higher than XXXX) to be able to enjoy the TowerTray's performance also with those printers. Otherwise the printer/TowerTray system will have an extreme low throughput due to printer problems only affecting TowerTray. Earlier HP LaserJet 4250 or 4350 printers can be upgraded to work with TowerTray (an exchange of the printers DC-controller is required). Please contact the HP Help Line for further information and refer to service note Q5400A-02.

# OPERATING

---

## Reloading Paper

While feeding occurs from a higher tray, lower ones may be reloaded without interrupting feeding and printing. To reload paper please refer to 'Loading Paper'.

The printer panel message  
(n = drawer number)

TRAY n LOAD  
Media Type & Size

indicates that the printer does not see the requested paper. In this case please refer to the following section 'Out of Paper'.

## Out of Paper

If a TowerTray tray runs out of paper, the printer will automatically switch to another tray with the same paper size and type (depending on the printer settings). If that paper is not available from another tray, the red Attention LED on the printer panel will start blinking and the printer message appears

TRAY n LOAD  
Media Type & Size

- Refill the tray with the correct paper and close the tray.

## Paper Jam

**Note:**

It is best to first try to clear jams and continue printing without turning the units off.

In case of a paper jam, the printer panel Attention LED will start blinking and the printer display will show a respective message with the following meaning:

13.01 PAPER JAM	paper jam in printer
13.11 PAPER JAM	paper jam in TowerTray
13.20 PAPER JAM	paper jam in TowerTray and printer

- In case of a **printer paper jam**, you will see the following messages:



13.01 PAPER JAM  
IN TRAY n

Remove the paper jam and all other pages in the paper path and close all the cover(s). Printing will continue. For more details on clearing printer paper jams please refer to your printer manual (Chapter Maintenance and Trouble Shooting, Section Paper Jams).

- In case of a **TowerTray paper error**, the following messages will be displayed:

13.11 PAPER JAM  
IN INPUT ACCESSORY

and TowerTray will beep with either one of the following sequences (depending on type of error):

 or
 

(TowerTray Paper Jam) (TowerTray Motor Block)



Open the TowerTray trays, starting with the lowest one. TowerTray beeping will stop when the tray which fed the last sheet is opened. Remove the jammed paper from the TowerTray paper path. Close all TowerTray trays. Printing will continue automatically.

- In case of a **paper jam in printer and TowerTray**, the following messages will appear

13.20 JAM  
TOP COVER AREA

13.11 PAPER JAM IN  
INPUT ACCESSORY

and TowerTray will beep with either one of the following sequences (depending on type of error):

 or
 

(TowerTray Paper Jam) (TowerTray Motor Block)

Open the TowerTray trays, starting with the lowest one. TowerTray beeping will stop when the tray which fed the last sheet is opened. Remove the jammed paper from the TowerTray paper path. Close all TowerTray trays. If printing does not continue automatically check the paper path within the printer for any remained sheet.

# PAPER QUALITY GUIDELINES

---

## General

For paper storage and quality specifications, please consult the relevant paper recommendations by Hewlett-Packard for the Q2440B tray.

### HP LaserJet Duplexer Option

The printer's duplexing capabilities remain fully supported with the TowerTray paper handling option installed.

### Original HP 500-Sheet Tray

- On HP LaserJet 4250/4350 up to three original HP 500-Sheet Tray and one standard 500 Sheet Tray can be operated in conjunction with the TowerTray, which itself can consist of a maximum of four TowerTray Trays, bringing it to a total of eight Trays 500 Sheet Trays.
- The optional HP 1500 sheet feeder may NOT be used in conjunction with TowerTray.

### POWERSAVE Function (Printer Setting)

HP LaserJet 4250/4350: The POWERSAVE function is fully supported with TowerTray installed.

### Printing on the wrong Paper

*Why doesn't it print from the tray I selected?*

If a selected Tray # ran out of paper or does not contain the paper size assigned for the print job, the printer might look for other trays containing the demanded paper size, and if this is available (and with the same Media Type as Tray #) will pull paper from there.

### The 3 Rules For Correct Paper Selection

- 1. Assign a different Paper Type to every Tray # by using the printers control panel.**  
You can assign the same Paper Type to two or more tray numbers only if these trays all contain the same Paper Type.
- 2. Make sure that you select the correct Paper Size for the selected Paper Type.**  
The selected Paper Size in the application software must be the same as what the size of that paper in the printer actually is.
- 3. Select paper within your application by Paper Type or by Tray #.**  
If a tray containing the selected Paper Type runs out, the printer will pull paper from other trays only if they have the same Paper Size and Type.

### Paper Control and Selection

#### *Selection Criteria*

The HP LaserJet offers various possibilities to select paper by offering three selection criteria:

- Paper Size
- Paper Source (Tray number)
- Paper Type (Media type)

The selection criteria differ in their priorities and can be changed using the JetAdmin utility software.

#### *Paper Types*

The Paper (Media) Type is a selection criteria which can be used to name trays and to distinguish between different paper types within a given paper size. The HP LaserJet offers 12 predefined Media Types.

The Media Types are: Plain, Preprinted, Letterhead, Transparency, Prepunched, Labels, Bond, Recycled, Color, Card Stock, and Rough.

#### *Default Paper Type*

Without a specific paper type assigned to a Tray, Plain becomes the default paper type. To assign a paper type to a Tray number using the printer control panel, please refer to Papertype Assignment of this manual.

**Creating Paper Sequences for a Word Document**

It is widely known that in Page Setup you have the possibility to enter different paper sources for First Page and Other Pages. If there are other pages in the document, which have to be printed on another paper, this can be defined in the same Page Setup window. In this window there is a pull-down bar *Apply to:* which is used for that purpose. The default setting is *Whole document* but there are also the options *This point forward* and *Selected text*, which can be selected.

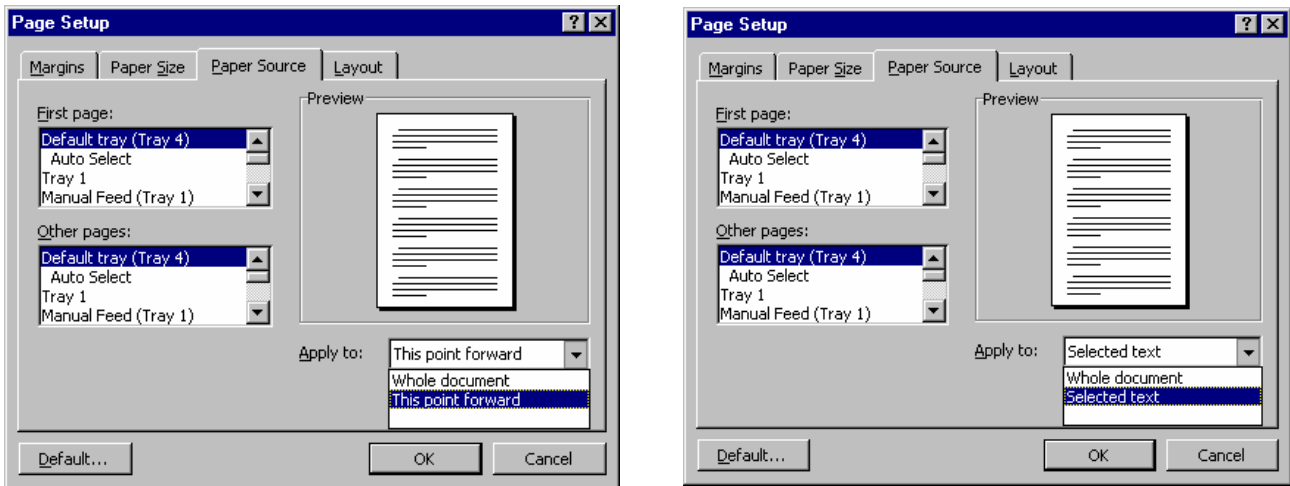

The option *Apply to:* allows to force a change of the paper source for a specific page or from a specific page onwards and thus to define paper sequences for a whole document.

**Printing a Document with copies on the HP LaserJet with TowerTray**

When printing a document you get either an original copy (copies = 1), or, if you set copies = n, you will get n times the same printout. Usually you want the original document to distinguish from its copies. An elegant method for that purpose is to print the copies on different (color) paper. This can be done by sending the print job several times to the printer but with different page settings. Using a Macro makes this an easy task.

On the next page you find an example of a macro used with a Word document. The macro starts with 'Sub Macro' and ends with 'End Sub'. It consists of several modules (one per copy) which contain the paper definitions for each copy (FirstPageTray = xx; OtherPagesTray = yy).

You can use the Macro Recording function of Word (Extra-Macro-Record) to produce the first module by performing the steps for Page Setup and Print. Then, in Macro Edit mode, you copy/paste this module to have one for each copy to print (one module per copy). Finally you edit the entries in FirstPageTray = xx; OtherPagesTray = yy to the desired paper sources.

This will produce a macro which prints the document in multiple copies and with the respective page settings. Such a macro can be incorporated into a Menu item or added as icon into the Toolbar.

Hint: When creating and adding a Macro to the Toolbar for automatic printing of the final document with its copies, it might be useful to also create and add a second Macro for easy printing of document drafts on cheap paper.

## APPENDIX B - Tips & Hints

---

The following table shows the internal denominations of the paper sources:

HP LaserJet		Media Type
Tray	Denomination	
TF 1	256	e.g. Letterhead
TF 2	257	e.g. Plain
TF 3	258	e.g. Bond
TF 4	259	e.g. Color

TF = TowerTray Tray

### Example:

The following Word Macro will produce an original document (on company paper) incl. 2 copies (plain and color).

Page	Original (Copy 1)	1 <sup>st</sup> Copy (Copy 2)	2 <sup>nd</sup> Copy (Copy 3)
First Page	Letterhead	Plain	Color
Other Pages	Bond	Plain	Color

### Macro Start

Sub Macro1 ()

Macro1 Macro

Macro recorded 30.08.04 by ...

```
With ActiveDocument.PageSetup
.LineNumbering.Active = False
.Orientation = wdOrientPortrait
.TopMargin = CentimeterToPoints (2.5)
.BottomMargin = CentimeterToPoints (2)
.LeftMargin = CentimeterToPoints (3)
.RightMargin = CentimeterToPoints (1.5)
.Gutter = CentimeterToPoints (0)
.HeaderDistance = CentimeterToPoints (1.25)
.FooterDistance = CentimeterToPoints (1.25)
.PageWidth = CentimeterToPoints (21)
.PageHeight = CentimeterToPoints (29.7)
.FirstPageTray = 257
.OtherPagesTray = 258
.SectionStart = wdSectionNewPage
.OddAndEvenPagesHeaderFooter = False
.DifferentFirstPageHeaderFooter = False
.VerticalAlignment = wdAlignVerticalTop
.SuppressEndnotes = False
.MirrorMargins = False
```

End With

```
ActiveDocument.PrintOut
```

```
With ActiveDocument.PageSetup
.LineNumbering.Active = False
.Orientation = wdOrientPortrait
.TopMargin = CentimeterToPoints (2.5)
.BottomMargin = CentimeterToPoints (2)
.LeftMargin = CentimeterToPoints (3)
.RightMargin = CentimeterToPoints (1.5)
.Gutter = CentimeterToPoints (0)
.HeaderDistance = CentimeterToPoints (1.25)
.FooterDistance = CentimeterToPoints (1.25)
.PageWidth = CentimeterToPoints (21)
.PageHeight = CentimeterToPoints (29.7)
.FirstPageTray = 258
.OtherPagesTray = 259
.SectionStart = wdSectionNewPage
.OddAndEvenPagesHeaderFooter = False
.DifferentFirstPageHeaderFooter = False
.VerticalAlignment = wdAlignVerticalTop
.SuppressEndnotes = False
.MirrorMargins = False
```

End With

```
ActiveDocument.PrintOut
```

```
With ActiveDocument.PageSetup
.LineNumbering.Active = False
.Orientation = wdOrientPortrait
.TopMargin = CentimeterToPoints (2.5)
.BottomMargin = CentimeterToPoints (2)
.LeftMargin = CentimeterToPoints (3)
.RightMargin = CentimeterToPoints (1.5)
.Gutter = CentimeterToPoints (0)
.HeaderDistance = CentimeterToPoints (1.25)
.FooterDistance = CentimeterToPoints (1.25)
.PageWidth = CentimeterToPoints (21)
.PageHeight = CentimeterToPoints (29.7)
.FirstPageTray = 257
.OtherPagesTray = 257
.SectionStart = wdSectionNewPage
.OddAndEvenPagesHeaderFooter = False
.DifferentFirstPageHeaderFooter = False
.VerticalAlignment = wdAlignVerticalTop
.SuppressEndnotes = False
.MirrorMargins = False
```

End With

```
ActiveDocument.PrintOut
```

End Sub

**Macro End**

## APPENDIX C - Standard Applications

---

### Where to select Paper Size and Paper Type

You select the TowerTray option paper sources from your standard application software the same way as the regular printers paper sources.

Please also refer to Appendix B (Tips & Hints - The 3 Rules For Correct Paper Selection) for recommendations on which paper selection criteria to use.

Below you will find the information on where to set the paper selection parameters in the most common standard applications.

MS-WORD:	File - Page Setup -	Paper Size: Paper Source:
----------	---------------------	------------------------------

EXCEL:	File - Print - Printer - Setup -	Paper Size: Paper Source:
--------	----------------------------------	------------------------------

	File - Page Setup - Page - Options:	Paper Size: Paper Source:
--	-------------------------------------	------------------------------

WRITE:	File - Print - Setup	Paper Size: Paper Source:
--------	----------------------	------------------------------

**Caution:**

Paper source settings in the property or the printer driver are overwritten by the appropriate settings in the application!

## APPENDIX D - PCL Paper Selection Commands

Frequently used PCL commands for Paper Selection:

Command	Function	# Refers to	LJ 42x0 / 43x0 LJ 42x0 / 43x0 N	LJ 42x0 / 43x0 T LJ 42x0 / 43x0 TN																																							
ESC & I # H	Selects Paper Source	0 2 3 7 4 1 8 5 6 20 (TowerTray 1) 21 (TowerTray 2) 22 (TowerTray 3) 23 (TowerTray 4)	print/eject page Man. Feed - Paper Man. Feed - Env. Auto Select Tray 1 Tray 2 (500-sheet Tray ) NA Envelope Feeder Tray 3 Tray 4 Tray 5 Tray 6	print/eject page Man. Feed - Paper Man. Feed - Env. Auto Select Tray 1 Tray 2 (500-sheet Tray ) Tray 3 Envelope Feeder Tray 4 Tray 5 Tray 6 Tray 7																																							
ESC & I # A	Sets Paper Size	2 = Letter 3 = Legal 26 = A4 for other sizes please refer to your printer manual																																									
ESC & n # Wd mediatype	Selects Media Type		<table border="1" style="width: 100%; border-collapse: collapse;"> <thead> <tr> <th style="width: 15%;">#</th> <th style="width: 45%;">mediatype</th> <th style="width: 40%;">Panel Display**</th> </tr> </thead> <tbody> <tr><td>n/a</td><td>Any</td><td>ANY</td></tr> <tr><td>6</td><td>Plain</td><td>PLAIN</td></tr> <tr><td>11</td><td>Preprinted</td><td>PREPRINTED</td></tr> <tr><td>11</td><td>Letterhead</td><td>LETTERHEAD</td></tr> <tr><td>13</td><td>Transparency</td><td>TRNSPRNCY</td></tr> <tr><td>11</td><td>Prepunched</td><td>PREPUNCHED</td></tr> <tr><td>7</td><td>Labels</td><td>LABELS</td></tr> <tr><td>5</td><td>Bond</td><td>BOND</td></tr> <tr><td>9</td><td>Recycled</td><td>RECYCLED</td></tr> <tr><td>6</td><td>Color</td><td>COLOR</td></tr> <tr><td>11</td><td>Card Stock</td><td>CARDSTOCK</td></tr> <tr><td>6</td><td>Rough</td><td>ROUGH</td></tr> </tbody> </table> <p style="text-align: center;">**indication for reference purposes only</p>		#	mediatype	Panel Display**	n/a	Any	ANY	6	Plain	PLAIN	11	Preprinted	PREPRINTED	11	Letterhead	LETTERHEAD	13	Transparency	TRNSPRNCY	11	Prepunched	PREPUNCHED	7	Labels	LABELS	5	Bond	BOND	9	Recycled	RECYCLED	6	Color	COLOR	11	Card Stock	CARDSTOCK	6	Rough	ROUGH
#	mediatype	Panel Display**																																									
n/a	Any	ANY																																									
6	Plain	PLAIN																																									
11	Preprinted	PREPRINTED																																									
11	Letterhead	LETTERHEAD																																									
13	Transparency	TRNSPRNCY																																									
11	Prepunched	PREPUNCHED																																									
7	Labels	LABELS																																									
5	Bond	BOND																																									
9	Recycled	RECYCLED																																									
6	Color	COLOR																																									
11	Card Stock	CARDSTOCK																																									
6	Rough	ROUGH																																									

## APPENDIX E - Troubleshooting

### Diagnosing an Error Situation

When calling for support, please have the Printer test pages at hand (Configuration Page, Menu Map and Event Log Page as per APPENDIX G).

Pos	LED	Printer Display	TF Beeping	Description	Action / Remarks
1	ON	..... TRAY n OPEN ..... READY .....		Tray n open	Close Tray
2	ON	..... TRAY n EMPTY ..... READY .....		Empty Tray without pending print request	Reload Tray n
3	ON	..... TRAY 1 LOAD Media Type & Size .....		Requested paper not available	Load Tray 1 with the correct size  See printer manual to change Media Size and Type through the printer control panel.
4	ON	..... TRAY n LOAD Media Type & Size .....		Paper requested from empty Tray n	Refill Tray n  Switches automatically to next Tray with same Size & Type and pulls paper from there (depending on settings).
5	ON	..... 13.01 PAPER JAM IN TRAY n .....		Paper jam in Printer	Clear paper jam and all other sheets from the paper path. Open/close printer cover(s)  Also refer to section 'OPERATING - 'Paper Jam' in this manual and to your printer manual for further details.
6	ON	..... 13.20 JAM IN TOP COVER AREA .....	Beep Type 2 or	Paper jam in Printer and TowerTray	Clear paper jam in printer and TF. Close TF Tray(s) and printer cover(s).
		..... 13.11 PAPER JAM IN INPUT ACCESSORY .....	Beep Type 3	Paper jam in TowerTray, and TowerTray Motor blocked	Remove all sheets from TF and printer paper path. Close TF Tray(s) and printer cover(s). In case error stays, call Service.
7	ON	..... 13.11 PAPER JAM IN INPUT ACCESSORY .....	Beep Type 2 or	Paper jam in TowerTray	Clear paper jam in TF. Close TF Tray(s).
		..... 13.11 PAPER JAM IN INPUT ACCESSORY .....	Beep Type 3	TowerTray Motor blocked	Open TF Tray(s). Remove all sheets from the TF paper path. Close TF Tray(s). In case error stays, call Service.
8		..... INITIALIZING .....		Printer display does not switch to READY	Turn the printer off and on again and switch off the POWERSAVE function.

## TowerTray Beep Types

<b>Type 0</b> (1x short)	■	TowerTray Reset Beep (e.g. after Power ON)
<b>Type 1</b> (short - short)	■ ■ ■ ■ ■ ■ ■ ■ .....	Paper in TowerTray paper path after a printer Reset
<b>Type 2</b> (long - long)	■■■■ ■■■■ ■■■■ ■■■■ .....	Paper Jam in TowerTray
<b>Type 3</b> (short - long)	■ ■■■■ ■ ■■■■ ■ ■■■■ .....	TowerTray Motor blocked
<b>Type 4</b> (6x short)	■ ■ ■ ■ ■ ■	Opening a TowerTray tray during a feed cycle

## Other Error Conditions

Pos	Description	Action / Remarks
9	TowerTray Trays not showing up in <i>Paper Sources</i> of the Printer Dialog	Check for correct printer driver

## APPENDIX F - Printer Selftest Pages

The following three functions allow you to print out information about your printing system configuration. These pages can be selected via printer panel (Item: INFORMATION MENU).

**Note:**

The information for the configuration page are recorded at power-up time. There is no update of the changes after power-up.

### Configuration Page

This page will be printed via printer panel (INFORMATION MENU - PRINT CONFIGURATION). Of particular interest are the indications under Paper Trays and Options where you can see:

**Paper Trays and Options**

- PH Controller (Revision) PHC
- Device 1:

TOWERTRAY option with configuration,  
Firmware Revision of Option PCB/Logic PCB,  
installed trays [size code\*] and tray capacity  
\*[size codes]: A4=1 , US Letter=2 , US Legal=3

**Event Log**

- Shows the last 3 errors incl. TowerTray errors.

TF Error Codes 13.11.xx	1**	2**	3**	4**
TowerTray Motor blocked	15 (21)	16 (22)	17 (23)	18 (24)
TowerTray Paper Jam	1F (31)	20 (32)	21 (33)	22 (34)
Tray opened while feeding	29 (41)	2A (42)	2B (43)	2C (44)
Printer Jam	33 (51)	34 (52)	35 (53)	36 (54)

Values für HP-LJ 4250 /  
4350 shown in brackets

\*\* Number of TowerTray tray (not printer tray) which feed the last sheet

### Paper path test page

The Menu Map page can be selected via printer panel (INFORMATION MENU - PRINT MENU MAP). This page is showing the different paper sources and its allocated Media Types.

**PAPER HANDLING MENU**

showing paper sources (trays) with the allocated Media Types, e.g.  
Tray 4 TYPE = LETTERHEAD

### Event Log Page

Via printer panel (INFORMATION MENU - PRINT EVENT LOG) you can print the Event Log Page showing the last 50 system errors including an error code for identification. Very helpful for diagnosing purposes!

TowerTray error codes:      HP LJ  
                                    13.11.xx                                      TowerTray Error  
                                    13.11.xx  
                                    xx = see in above event log chart

**Note:**

Whenever calling for service, please make sure to have these information pages at hand (configuration page, event log page and the serial no. of your TowerTray unit).

# hp LaserJet 4350 printers



## configuration page

1

### Printer Information

Product Name: hp LaserJet 4350  
 Printer Name: hp LaserJet 4350  
 Model Number: CXXXXA  
 DC Controller: 19  
 Printer Serial Number: CN2C489G01  
 Formatter Number: S46XXXXXXX  
 Firmware Datecode: 20050304 08.008.6  
 Service ID: 14339  
 PS Wait Time-out: 300 seconds  
 Page Count: 4050  
 Maintenance Kit Interval: 225000  
 Pages Since Last Maintenance: 4014

### Memory

Total RAM: 80 MB  
 DWS: 14.00  
 Automatic Resource Saving Enabled

### Event Log

Number of Entries in Use: 50  
 Maximum Number of Entries: 50  
 Three Most Recent Entries:

Number	Page Count	Entry
50	4002	49 210A
49	3881	13.11.44
48	3881	13.11.54

### Installed Personalities and Options

PCLXL (20010402)  
 PCL (20010402)  
 PS (20010402)  
 DIMM Slot 1: 80 MB DDR  
 DIMM Slot 2: Empty  
 Card Slot 1: Empty  
 Card Slot 2: Empty  
 EIO 1: Empty  
 EIO 2: HP JetDirect J4169A  
 RAM DISK Storage: 36 MB Capacity

### Security

Control Panel Lock: NONE  
 Control Panel Password: DISABLED  
 Write Protect: DISABLED  
 File System Access:  
 PjL: ENABLED  
 PML: ENABLED  
 NFS: ENABLED  
 PostScript: ENABLED

### Paper Trays and Options

Default Paper Size: A4  
 Tray 1 Size: A4  
 Tray 2 Size: A4  
 Tray 3 Size: A4  
 Tray 4 Size: A4  
 Tray 5 Size: A4  
 Tray 6 Size: A4  
 Tray 7 Size: A4  
 Tray 8 Size: A4  
 TowerTray TT/22.10.xx [1111]

ENGLISH (1)

Please refer to page 26 for more information on this page.

**hp LaserJet 4350 printers** 

**paper handling configuration page** 1

**Product Name: TowerTray**

Model: TT/22.10.x  
Firmware Datecode: 3.10/2.30  
Input Trays:  
1: TRAY 5, 500 Sheets  
2: TRAY 6, 500 Sheets  
3: TRAY 7, 500 Sheets  
4: TRAY 8, 500 Sheets

TowerTray  
Firmware version  
(Logic/Jetlink)

ENGLISH (1)

Please refer to page 26 for more information on this page.

## hp LaserJet 4350 printers



event log page
1

Current Page Count: 35      Serial Number: CN2C489G01

Number	Page Count	Event	Description or Personality
3	20	13.11.54	EXTERNAL INPUT DEVICE PAPER JAM
2	20	13.11.44	EXTERNAL INPUT DEVICE PAPER JAM
1	22	13.11.21	EXTERNAL INPUT DEVICE PAPER JAM



Error / Event code explanation see page 26

Please refer to page 26 for more information on this page.

## APPENDIX G - TowerTray Selftest

---

### TowerTray Selftest Feature

The TowerTray selftest feature allows to test the TowerTray unit independently from any printer and computer. With this test you can check for correct paper feeding (horizontal position, skew, jam behavior).

**Note:**

To perform a TowerTray selftest, remove the printer's paper cassette.

Follow the following steps:

- Power-off TowerTray.
- Open all TowerTray Trays (approx. 10 cm).
- Power-on TowerTray.
- Wait until you hear a short beep followed by the clicking of the solenoid activation in every module, and finally the spinning of the motor (approx. 2 sec).
- Close the top-most TowerTray tray. After a second a sheet will be fed from this drawer. You now can mark the position of the left border of the sheet on the TowerTray top cover (reference for horizontal paper position).
- Pull out the sheet from its waiting position. TowerTray will automatically feed a next sheet. You now can compare the position of the left border of the next sheet. If it moves up straight in the same position, this is ok. (In case the left position would be different, or moving from left to right (or vice-versa), this might indicate a problem in either the tray, the unit (module) or the paper loading.)
- To test the next lower tray, close that tray before removing the sheet from its waiting position. Now TowerTray will feed the sheet from that next lower tray. (TowerTray will always feed the next sheet from its lowest closed tray.)
- To revert to normal operation, power-off and on TowerTray again with all trays closed. TowerTray will respond with a short 'Reset' beep that it is ready again.

In case error conditions are showing up which are depending on a specific TowerTray tray, you can swap trays to find out whether a problem exists with the tray itself or whether a specific module is the cause. Please note, that the top tray (part nr. 206012) MUST always be the topmost tray of TowerTray.

TowerTray does not require preventive maintenance. Cleaning of housing and removal of paper dust from within the TowerTray drawers might now and then be indicated.

**Clean the outside** of TowerTray with a lightly water-dampened cloth. Do not use detergents to avoid damage of the surfaces.

To **clean the paper drawers** from paper dust, completely remove the drawers from TowerTray, remove the paper and use a vacuum cleaner with a soft brush.

**For further references see our WebPages: [www.key2printing.com](http://www.key2printing.com)**

**Warning:**

To avoid damage to the paper-out sensor arms do not reach into the openings for the paper drawers.

## APPENDIX I – TowerTray Specifications

---

<b>Dimensions and Weights:</b>	<i>Model Designation</i>	<i>Width</i>	<i>Depth</i>	<i>Height</i>	<i>Weight</i>
Basic Configuration (two trays)	TT/22.10.00	475 mm	510 mm	360 mm	25.0 kg
Middle tray (up to two of them)	206011	415 mm	450 mm	125 mm	7.0 kg

**Paper Specifications:** as HP-Tray specifications in your printer manual

**Paper Trays:** as HP-Tray specifications in your printer manual

**Tray capacity:** Up to 500 per tray

**Temperature:** Operating: 10°C to 32°C (50°F to 90°F)  
Storage: -25°C to 50°C (-13°F to 122°F)

**Relative humidity):** Operating: 30% to 80%  
(non-condensing, ment for Tower Tray not for paper) Storage: 5% to 95%

**Note:** Observe recommended storage conditions for paper (see 'HP-Tray specifications in your printer manual').

**Power Requirements:** Voltage 100 - 230 V~ (+/-10%)  
Frequency 50 – 60 Hz  
Current 1.5 A max.



D&P International B.V., Netherlands, reserves the right to make changes to its products or services without prior notice and without incurring any obligations to incorporate such changes in units or publications shipped.

**D&P International B.V. shall in no event be liable for incidental or consequential damages arising from the use of its equipment.**

TowerTray™ - manufactured by

D&P International B.V.  
Jan Valsterweg 72  
3315 LG Dordrecht  
The Netherlands

Tel: +31 (0) 78 630 90 30  
Fax +31 (0) 78 630 74 44  
e-mail [support@key2printing.com](mailto:support@key2printing.com)  
Internet: [www.key2printing.com](http://www.key2printing.com)

